

## AP-M Series HIGH-POWER INTERCOM

Models: **AP-1M,** 1-call master  
**AP-5M,** 5-call master  
**AP-10M,** 10-call master Type A: 230V AC version

### INSTALLATION MANUAL

#### PRECAUTIONS on AP-M SYSTEM

##### ⚠ Precautions on Safety

1. The **AP-M** equipment is an electrical device, whose wiring must be done by qualified personnel.
2. Do not change or modify **AP-M** equipment.
3. Keep **AP-M** station away from water or any other liquid. It can cause fire or electric shock.
4. Do not open **AP-M** station. High voltage is present inside.

##### General Precautions

1. Do not install or make any wire terminations while power supply is turned on. It can cause electric shock or damage the unit.
2. Do not install **AP-M** components in any of the following locations, as it may cause the system to malfunction:
  - High or extreme cold temperature areas: under direct sunlight, near equipment that varies in temperature, in front of air-conditioner, inside a refrigerated area, etc.
  - Places subject to moisture or humidity extremes.
  - Places subject to environmental conditions, such as oil, dust, chemicals, salt, etc.
  - Places subject to constant vibration or impact.
3. Make sure wires are connected properly before plugging in the unit.
4. When mounting **AP-M** station on wall, select a location where protruded unit would not cause injury to people.

##### Precautions on Usage

1. **AP-M** system is not operable during a power failure.
2. In areas where broadcasting station antennas are close by, intercom system may be affected by radio frequency interference.
3. Keep all DC wiring at least 30cm, 20" away from AC 100 ~ 240V wiring, fluorescent lighting, or dimmer switches. Cross AC wiring at a 90° angle.
4. Severe weather conditions, such as lightning storms, may cause damage to **AP-M** equipment. The **AP-M** has a GROUND terminal, which is to be connected to an earth ground.

## 1 SYSTEM OUTLINE & COMPONENTS

AP-M is a High-Power Intercom with 10 watt power output. It can be configured in either single or dual master system in combination with remote 8Ω horn speakers and Aiphone's subs, desk or ceiling mount.

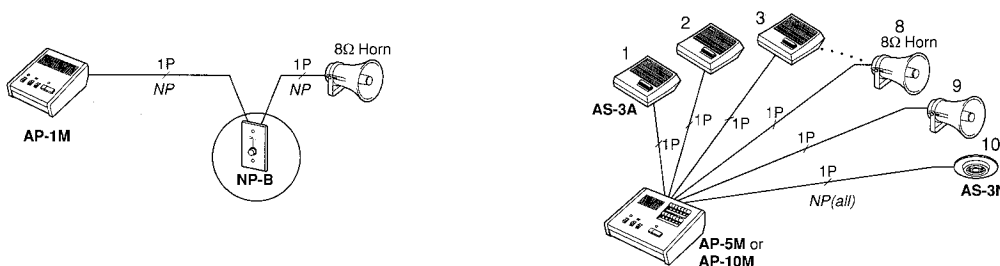

★ Use a twisted pair cable for each sub (non-polarized).  
 For any 8Ω horn speaker, install a NP 25mfd, 25V capacitor in line with # wire (not required when NP-B is installed)

##### ■ Package contents

- Master station (AP-1M, AP-5M or AP-10M)
- Mounting bracket
- Packet of screws
- Installation & Operation Manual

## ■ Components available

### • Master stations

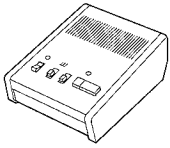

**AP-1M,**  
1-call master

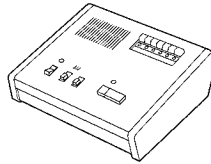

**AP-5M,**  
5-call master

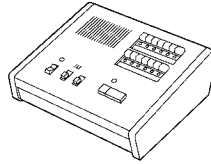

**AP-10M,**  
10-call master

### • Sub stations

#### Wall/desk

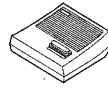

**AS-3A,**  
1-call sub

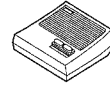

**AS-3WA,**  
Dual call

#### Ceiling mount

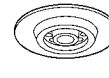

**AS-3N,**  
Ceiling

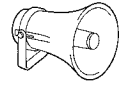

**8Ω horn speaker**

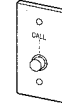

**NP-B,**  
Call button

### • Mounting accessories:

**N-EA:** Frame for AS-3N, ceiling surface-mount

**NBZ-M:** Ceiling flush-mount

**NP-W:** Surface-mount box for NP-B

## 2 NAMES AND FEATURES

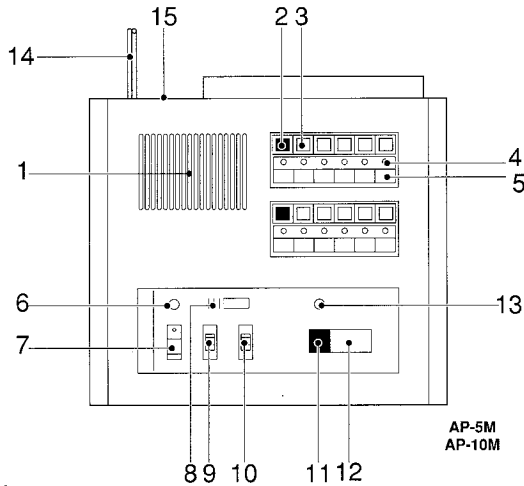

AP-5M  
AP-10M

1. Speaker
2. OFF button
3. Station selector button
4. Call-in LED
5. Directory card
6. Power on LED
7. Power switch
8. Mic.
9. RECEIVE volume control
10. TRANSMIT volume control
11. Tone CALL button
12. TALK/LISTEN button
13. Occupied LED
14. AC cord / plug
15. Preset receive & transmit volume controls

★ AP-5M: Second switch bank is not included.

### ■ Features

- One or two master configuration
- 1, 5, or 10-call master consoles
- 10 watt output
- Desk/wall or ceiling subs available

- 8Ω horn speaker w/talkback
- Separate transmit & receive volume controls
- Group call (selectively up to 5 subs)

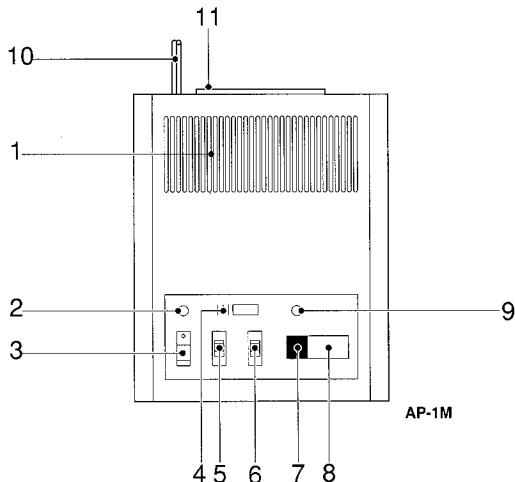

AP-1M

1. Speaker
2. Power on LED
3. Power switch
4. Mic.
5. RECEIVE volume control
6. TRANSMIT volume control
7. OFF button
8. TALK/LISTEN button
9. Communication LED
10. AC cord/plug
11. Preset receive & transmit volume controls

### ■ Features

Same features as on AP-10M, except for single sub call capability.

# 3 WIRING

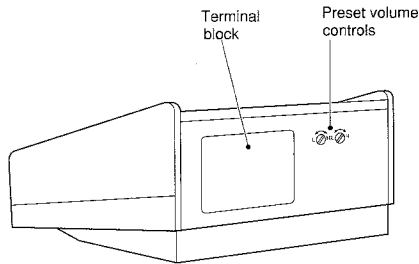

## • AP-5M terminals

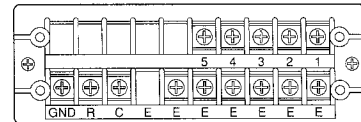

## • AP-10M terminals

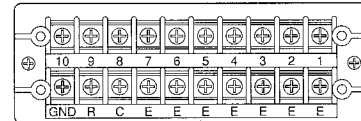

### ■ Terminal block layout

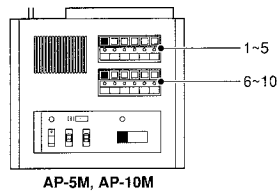

As shown, station numbers 1 ~ 5 (top row) & 6 ~ 10 (2nd row) are assigned, corresponding to the terminal numbers.

- 1 ~ 5 or 1 ~ 10: Selective communication channels
- E : Common communication
- C : "CALL" for calling other master
- R : Occupied mode control
- GND : for grounding

### ■ Cable

Use a **single-twisted pair cable** for wiring between AP-M and each sub, homerun, or the other AP-M (In USA, cable # 832202 specified)

### ■ Wiring

In single-master configuration, wiring is non-polarized for any type of sub. In dual-master system, wiring of common sub(s), AS-3WA (2-call) and AP-M's becomes polarized.

### ■ 8Ω horn speaker

When using an 8Ω horn speaker and a call button is not required, insert a 25 mfd non-polar capacitor in one side of the line. If a 25 mfd capacitor is not available, two 50 mfd, 25V electrolytic capacitors may be used when connected in series + to +, or – to –, as shown.

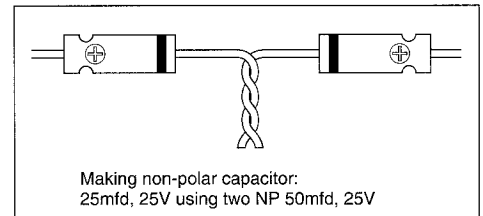

### ■ Wiring examples of NP-B call buttons

For AS-3N

1. Multiple NP-B's

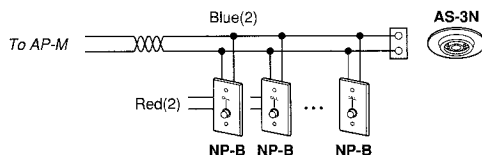

2. Local call switch

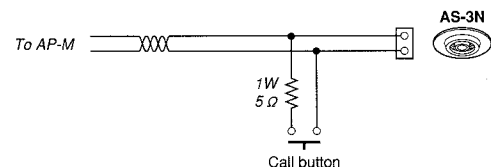

For 8Ω horn

1. Multiple NP-B's

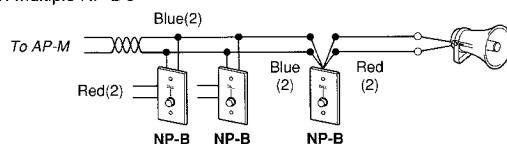

2. Local call switch

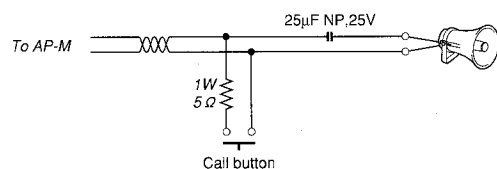

# WIRING DIAGRAMS

## AP-5M, AP-10M

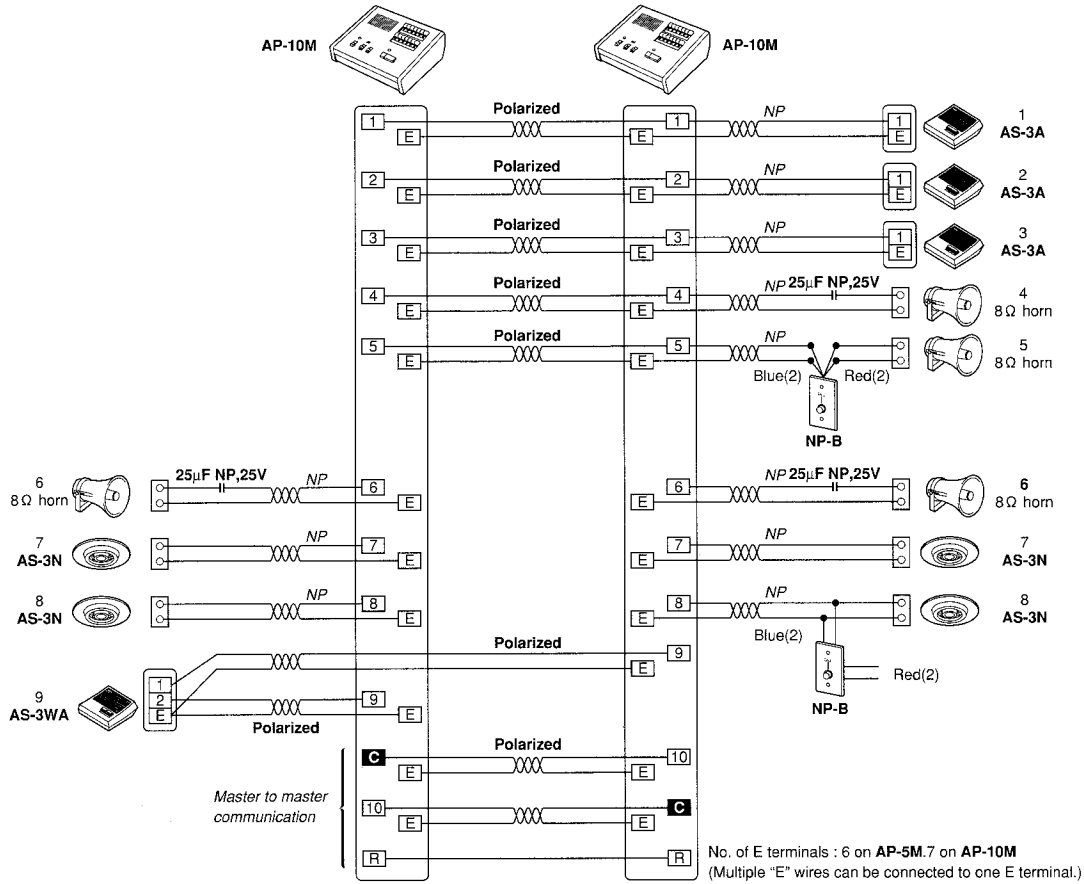

## AP-1M

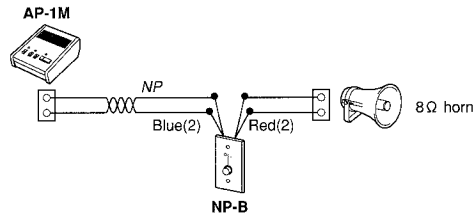

# 4 MOUNTING

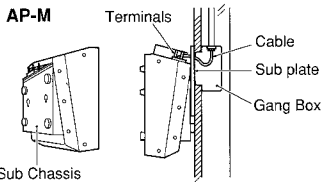

AP-M is designed for desk-top use. For wall-mounting, install sub-chassis upside down. Do not remove sub-chassis, which is necessary for heat radiation. Use a sub-plate for mounting on box.

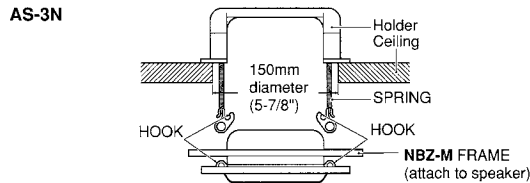

Open a hole 150mm $\phi$  (5-7/8") in the ceiling. (NBZ-M square frame may be attached from the back). Locate the holder on the ceiling, and mount AS-3N with 2 hooks.  
\* For surface-mounting, use N-EA round frame.

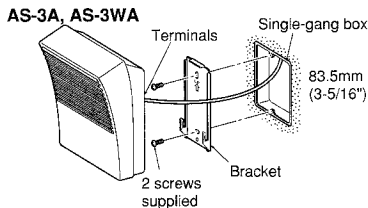

Attach the mounting bracket to box or wall. Mount the unit on the bracket until it firmly locks.

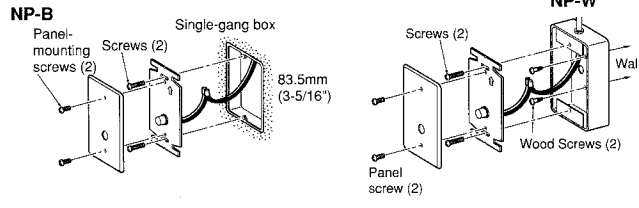

NP-B call switch flush-mounts to box, or surface-mounts on NP-W box.

# 5 OPERATIONS on AP-M

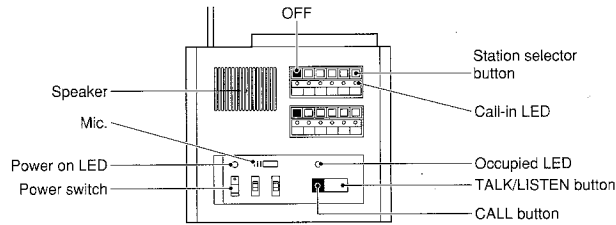

## ■ Placing a call to sub

1. Depress the station selector button of sub.
2. Depress CALL button to ring sub with mono tone.  
Or press TALK button and call with voice.
3. Release TALK button to listen.  
Press TALK button to reply.
4. At conclusion, depress OFF button.

## ■ Receiving a sub call-in

1. Monotone sounds, and a call-in LED is lit for 15 sec.
2. Depress the LED lit station selector button.
3. Press TALK button to talk and release to listen.
4. At conclusion, depress OFF button.

★ A call-in from sub during communication is indicated by a lit LED only.

## ■ Group Call (up to 5 subs)

1. Depress up to 5 station selector buttons.
2. Depress and hold down TALK button to transmit.
3. Depress OFF button(s) to reset.

## ■ Communication between AP-M's

The other AP-M calls in with tone or with voice direct.

Depress the other master's selector button. Initiating master uses TALK button to talk, and release to listen.

## ■ Volume adjustments

On front panel, set speech volumes as desired.

Replace to MID levels at end of each communication.

RECEIVE vol. , 3-position

TRANSMIT vol. , 3-position

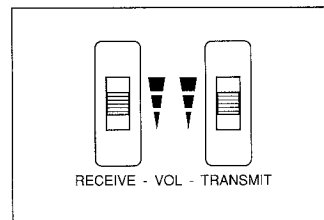

## ■ Sub stations: AS-3A, AS-3WA, 8Ω horn

To call, depress momentarily CALL button on AS-3A sub (either on AS-3WA) or on NP-B. It rings AP-M master with monotone, and an LED is lit for approx. 15 seconds. Master calls in with tone and/or voice directly. Just reply toward the unit hands free.

## ■ Operations on AP-1M

To call a sub with tone, press both OFF and TALK buttons. Or press TALK and call by voice.

Continue communications with TALK button.

When finished, depress OFF button.

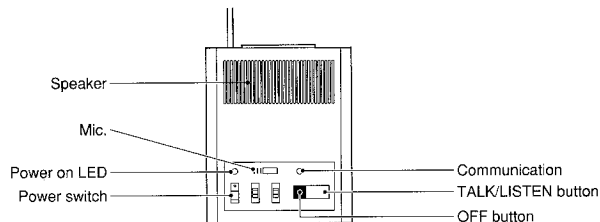

# 6 TECHNICAL PRECAUTIONS

- **Temperature:**  
AP-M is rated to operate between temperatures 0°C ~ +40°C (+32°F ~ +104°F).
- **Power switch:**  
If AP-M is unplugged or its power switch is turned off, it cannot receive sub's call nor transmit a call to subs. However, it can receive the other AP-M's call-in tone and voice.
- **Volume adjustments on back panel**  
Place two front controls to MID position and adjust volume to desired level with controls on back panel.
- **Cleaning:**  
Clean AP-M equipment with a soft cloth dampened with neutral household cleanser. Never use any abrasive cleaner or cloth.

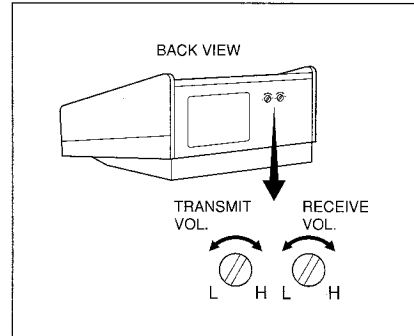

# 7 SPECIFICATIONS (AP-M)

- Power source: 110 ~ 125V AC, 127V AC, 220-240V AC, 50/60 Hz (AP-M). 230V AC, 50/60Hz (AP-M/A).
- Power consumption: Max. 45W, 4W standby (AP-M, AP-M/A).
- Communication output: AP-M to sub 10 watts max.  
AP-M to AP-M 0.3watts max.  
Sub to AP-M 0.3watts max.
- Calling & communication: Sub's call-in with mono tone & an LED lit for 15 sec. (tone only on AP-1M). Select and press to talk and release to listen. Speak hands free at sub.  
The other AP-M calls by voice. Reply hands free.
- Wiring: Twisted pair cable (In USA, 1 pair #832202 per station, specified).  
1 pair per sub (any type). 2 pairs + 1 between AP-M's.
- Distance: *Between AP-M to sub/AP-M;*

Diameter/AWG	0.65mmø	1.0mmø	22AWG	18AWG
Distance	150m	360m	490'	1,200'

- Dimensions & weight: *Desk use;*  
AP-1M; 240H x 196W x 114D (mm). 9-1/2"H x 7-3/4"W x 4-1/2"D.  
AP-5M, 10M: 253H x 276W x 140D (mm). 10"H x 11"W x 5-1/2"D.  
AP-1M: 3.2Kg (7.05 lbs.) AP-5M: 4.0Kg (8.82 lbs.) AP-10M: 4.2Kg (9.26 lbs.) approx.

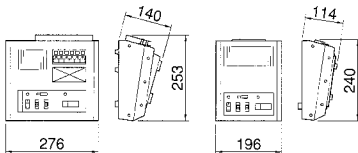

## WARRANTY

Aiphone warrants its products to be free from defects of material and workmanship under normal use and service for a period of one year after delivery to the ultimate user and will repair free of charge or replace at no charge, should it become defective upon which examination shall disclose to be defective and under warranty. Aiphone reserves unto itself the sole right to make the final decision whether there is a defect in materials and/or workmanship; and whether or not the product is within the warranty.

This warranty shall not apply to any Aiphone product which has been subject to misuse, neglect, accident, or to use in violation of instructions furnished, nor extended to units which have been repaired or altered outside of the factory. This warranty does not cover batteries or damage caused by batteries used in connection with the product.

This warranty covers bench repairs only, and any repairs must be made at the shop or place designated in writing by Aiphone. Aiphone will not be responsible for any costs incurred involving on site service calls.

AIPHONE CO., Ltd., Nagoya, Japan  
AIPHONE CORPORATION, Bellevue, WA, USA  
AIPHONE EUROPE NV, Antwerp, Belgium

